

DATASHEET

Type: **DOME**
Name: Pendant light
ID: PC1348
Designed by: LCM MARIN design studio



Download

Description

A nod to classical Roman architecture, the new Dome collection of pendant and table lights follows the success of Dome Nomad, an earlier collection inspired by the great domes of Venice and evoking the eternity and expansiveness of the celestial vault. The elegant shade, comprising multiple layers of molten glass, each carefully inspected by the master glassmaker prior to blowing, comes in either smooth or wavy clear glass.



Tech. description

The luminaire consists of a glass shade, metal frame with integrated LED module, metal printout on the lower edge of the screen, supply cable and steel cable. The luminaire is suspended from the ceiling canopy by means of a supporting steel cable.

CONSTRUCTION SPECIFICATION

Weight: 7.1 kg
Construction material: glass, metal
Cord length [mm]: 2,200 mm
Mounting: Ceiling
Environment: Indoor

DIMENSIONS [mm]

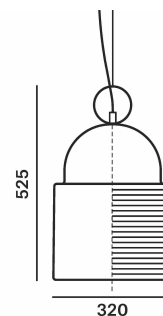

ELECTRICAL SPECIFICATION

Input voltage [V]: 100 - 240 V
Frequency [Hz]: 50-60 Hz
Max. power [W]: 17,5 W
Coverage IP: 20
Socket: LED module
Light source: -
Energy class: E

CERTIFICATIONS



BROKIS S.R.O.
ŠPANILOVA 1315/25
163 00 PRAHA 6 - ŘEPY
CZECH REPUBLIC

ORG ID 64940799
VAT ID CZ64940799
C 42174 MĚSTSKÝ SOUD
V PRAZE

TEL +420 567 211 517
TECHNICAL@BROKIS.CZ
INFO@BROKIS.CZ
WWW.BROKIS.CZ

2024_03
PAGE 1



CM17866

Type	LED module
Lamp wattage [W]	15 W
Input voltage [V]	24 VDC
Energy class	E
Flux [lm]	1617 lm
Light colour [K]	2700 K
CRI	90
Dimmable	yes

CM17914

Type	LED module
Lamp wattage [W]	15 W
Input voltage [V]	24 VDC
Energy class	E
Flux [lm]	1099-1782 lm
Light colour [K]	1800-6500 K
CRI	90
Dimmable	yes





INNER FIXTURE

Dimensions O x w [mm] 202 x 60 mm
Weight [kg] 1.15 kg
Material metal

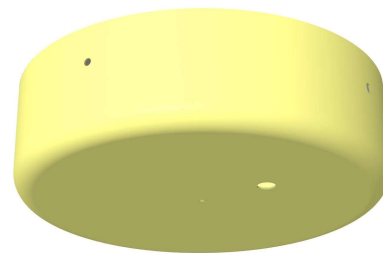

Drawing

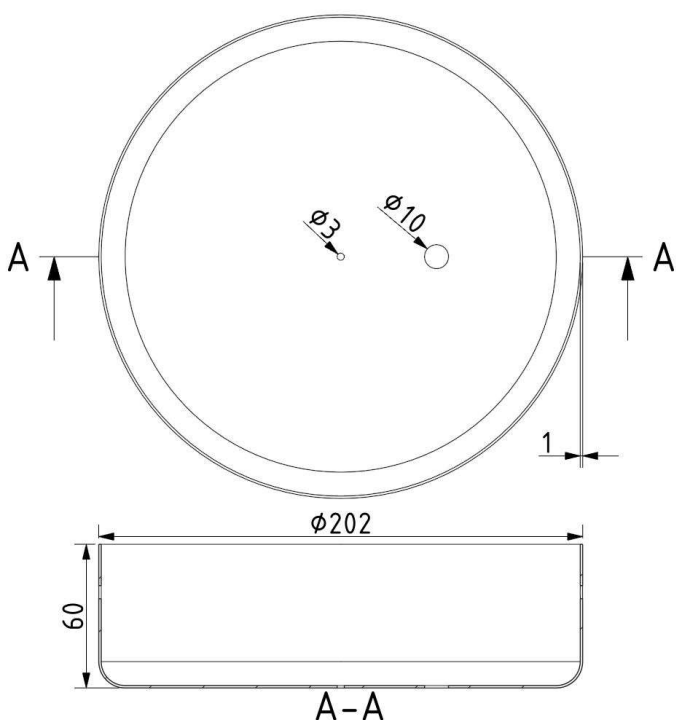

Hole placement

