

# MOSS

## ACOUSTIC OBJECT

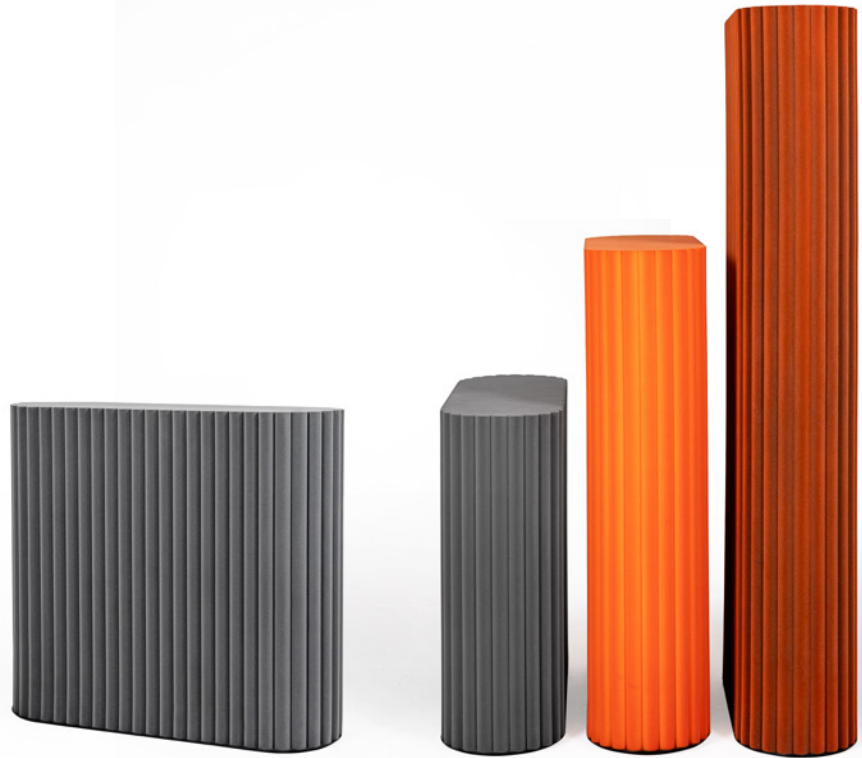





You'll be enchanted by the charming aesthetics and optimized functionality of MOSS. Its specialized materials enable it to absorb ambient sound and improve the office environment. MOSS is available in three sizes.





# TECHNICAL DETAILS

|                            |                                       |
|----------------------------|---------------------------------------|
| basic dimensions<br>SMALL  | 910 x 810 x 300 mm / 36 x 32 x 12 in  |
| basic dimensions<br>MEDIUM | 910 x 1210 x 300 mm / 36 x 48 x 12 in |
| basic dimensions<br>LARGE  | 795 x 1810 x 300 mm / 31 x 71 x 12 in |
| filling                    | high-performance acoustic foam        |
| finish                     | flock (color refer to swatches)       |
| acoustic properties        | NRC = 0,65 [-]; aw = 0,70 [-]         |
| base                       | lacquered steel                       |

|   |   |   |
|---|---|---|
|  |  |  |
| 8744<br>(grey)  | 8713<br>(grey)  | 8510<br>(yellow)  |
|  |  |  |
| 8100<br>(orange)  | 8120<br>(red)   | 8211<br>(blue)  |

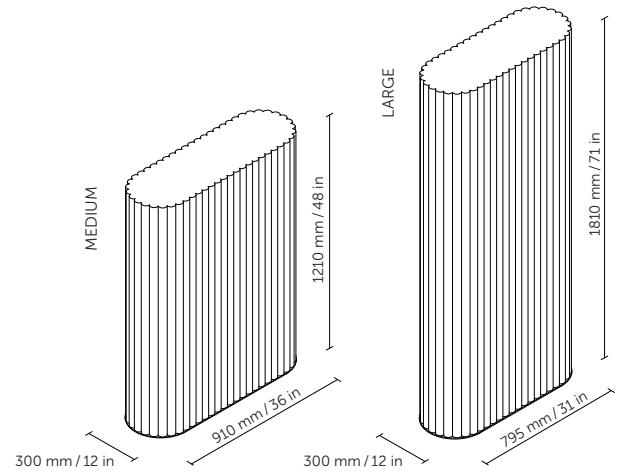
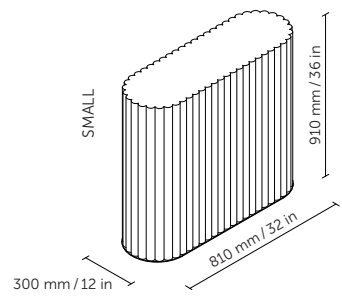

\* NRC – noise reduction coefficient (250 Hz–2000 Hz)  
aw – average absorption coefficients (250 Hz–4000 Hz)

All intellectual property rights („Rights“), whether registered or not, relating to any content, texts, photographs, images, logos, instructions, designs, technical solutions, etc. (“Content”) are the property of SilentLab s.r.o. (“Owner”) and any interference with these Rights to any Content or part thereof without the prior express and written consent of the Owner is not permitted.

Any use of the Content not expressly authorized in writing in advance, with the exception of internal and non-commercial use of the unmodified Content for the purposes of the customer’s own order, is considered an infringement of the Owner’s Rights. In particular (not exclusively), any reproduction, change, addition, merger or other modification of the Content is prohibited without the prior express written consent of the Owner.

The final product configuration may differ from the versions shown in the photographs.  
SilentLab® and its logo are registered trademarks of SilentLab s.r.o.

